

Clariflo®



WARNING: Do not use the hot washer without reading this manual

HOT WASHER MODEL NO: KING 150

PART NO: 7320175

OPERATION & MAINTENANCE INSTRUCTIONS



LS0316

INTRODUCTION

Thank you for purchasing this CLARKE hot washer.

The hot washer has been designed to use hot or cold water to clean any surfaces which can stand the force of the high pressure water jet and the action of the detergents used.

The hot washer must only be used for the purpose for which it was designed.

Before attempting to use this product, please read this manual thoroughly and follow the instructions carefully. In doing so you will ensure the safety of yourself and that of others around you, and you can look forward to your purchase giving you long and satisfactory service.

GUARANTEE

This product is guaranteed against faulty manufacture for a period of 12 months from the date of purchase. Please keep your receipt which will be required as proof of purchase.

This guarantee is invalid if the product is found to have been abused or tampered with in any way, or not used for the purpose for which it was intended.

Faulty goods should be returned to their place of purchase, no product can be returned to us without prior permission.

This guarantee does not effect your statutory rights.

LIST OF CONTENTS

The following items should be supplied in the carton. If any parts are missing or damaged, please see your Clarke dealer where you purchased the hot washer

1 x Hot Washer	1 x Cable / Hose Storage Bracket
1 x Gun Assembly	1 x Bottle for Detergent (Chemical)
1 x Lance Assembly	1 x Parts Pack
1 x High Pressure Hose Assembly	1 x Hose Adaptor
1 x Main Handle	1 x Nozzle Clearing pin

SAFETY WARNINGS



WARNING: READ ALL SAFETY WARNINGS BEFORE USING THE HOT WASHER.

WARNING: ALWAYS DISCONNECT FROM THE ELECTRICAL POWER SUPPLY AND REMOVE THE PLUG FROM THE SOCKET BEFORE CARRYING OUT ANY MAINTENANCE.

1. This hot washer is for outdoor use only.
2. Do not cover the top exhaust during use.
3. Always wear protective clothing, safety shoes and safety glasses. Loose particles & other debris may be propelled at high speed by the water jet.
4. Always disconnect the electricity and water supplies on completion of every job.
5. High pressure jets can be dangerous if subject to misuse. The jet must not be directed at persons, animals, live electrical equipment or the hot washer itself.
6. Do not operate the hot washer if the cover has been removed.
7. Do not use the hot washer if a power cable or important parts of the hot washer are damaged, e.g. safety devices, high pressure hoses, trigger, gun.
8. Do not direct the nozzle toward mechanical parts containing lubricating grease, as the grease will dissolve and spread over the surrounding ground.
9. Only use hoses, fittings and couplings recommended by Clarke International
10. Vehicle tyres/tyre valves may only be cleaned from a minimum distance of 30 cm, otherwise the vehicle tyre/tyre valve could be damaged by the high-pressure jet. The first indication of this is a discoloration of the tyre. Damaged vehicle tyres/tyre valves can be dangerous.
11. This hot washer should not be left in standby for more than 5 minutes.
12. Switch the hot washer off completely whenever it is left unattended.
13. Do not spray flammable liquids due to the risk of explosion.
14. Take care not to damage the power cable. If the power cable is damaged, it must be replaced by Clarke International service department.
15. Keep a firm hold of the spray gun and be prepared for kickback when you pull the trigger.
16. When the hot washer is working do not use it in an enclosed space where ventilation may be insufficient. NEVER cover the hot washer.
17. Do not let children or untrained personnel use this hot washer.

18. This hot washer is not intended for use by persons (including children) with reduced physical, sensory or mental capabilities.
19. Never start the hot washer without first completely unwinding the high-pressure hose.
20. Before unwinding or rewinding the hose, switch the hot washer off and release the pressure in the hose by pulling the trigger.
21. If an extension cable is used, the plug and socket must be of watertight construction.
22. Never use the hot washer during thunderstorms or when it is raining.
23. Do not attempt any electrical or mechanical repairs to this hot washer. Always refer to your Clarke dealer.
24. Do not supply any liquid other than water to the water inlet.
25. Never yank the power cable to disconnect the plug from the socket.
26. Only use chemical cleaning agents (detergents), that are approved for the hot washers. We recommend Clarke Traffic Film Remover or Clarke Wash and Wax (available from your Clarke dealer).

SAFETY SYMBOL

DO not spray people / animals or the hot washer itself.

Do not direct the spray at any electrical device or power outlet.

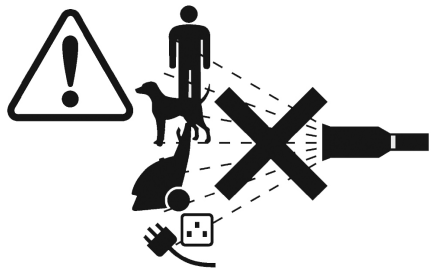

ASSEMBLY INSTRUCTIONS

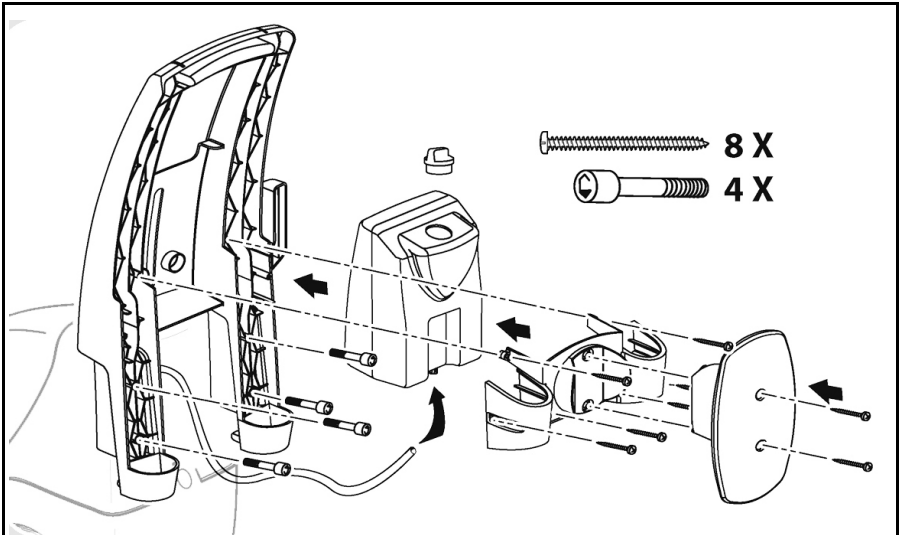

1. Fit the handle first then the detergent tank, followed by the tool holder and finally the hose hook to the hot washer as shown above using the 4 bolts (for the handle) and screws (for the tool holder, hose hook) supplied.

SETUP

1. Press 'O' on the master switch to make sure that the hot washer is turned off.

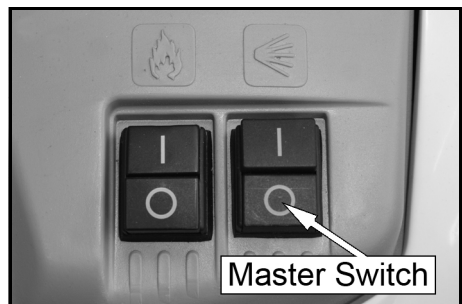

2. Check that the water filter is fitted into the pump's inlet pipe.
3. Screw the hose connector into place by hand, without the aid of tools until 'hand tight'.

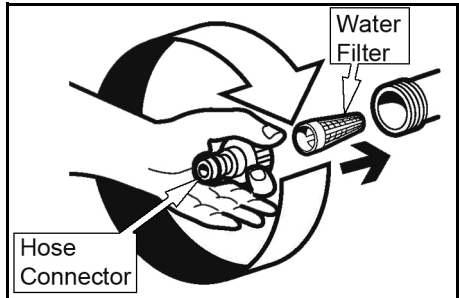

4. Connect the water supply hose to the hose connector. The hose must have an inside diameter of at least 13 mm (1/2").
 - The optional quick connector may be fitted.
 - Place the cleaner as close to the water supply as possible.

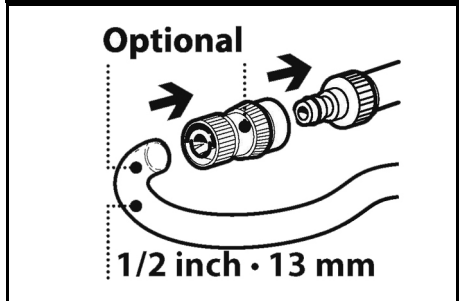

5. Connect the high pressure hose to the hot washer outlet pipe.
 - Press the high pressure hose coupling fully down and then screw into place by hand.
 - Tighten the connector hand tight only;- do not use any tools.
 - Make sure the connections are secure.

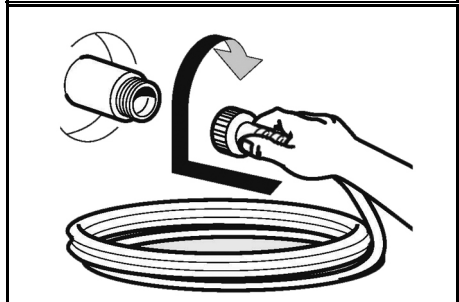

6. Screw the high pressure hose onto the gun assembly.
 - Use a spanner to tighten the connector.



7. Connect the spray lance to the gun assembly and tighten securely by turning the locking ring.

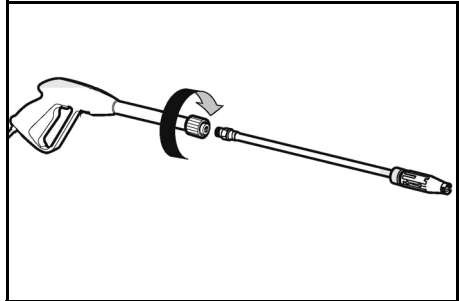

8. Turn the local water tap fully on.
- Minimum delivery rate: 15 l/min.
 - Maximum supply water temperature: 40°C.
 - Maximum supply water pressure: 1MPa.



WARNING: THE HOT WASHER CAN ONLY BE CONNECTED TO THE WATER MAINS IF SEPARATED BY A BACKFLOW PREVENTER. MAKE SURE THAT THE HOSE IS AT LEAST 13MM-1/2 INCH IN DIAMETER AND IS REINFORCED.

WARNING: WATER THAT HAS PASSED THROUGH A BACKFLOW PREVENTER IS CONSIDERED TO BE NON-DRINKABLE.

9. Release the trigger lock and keep the trigger pressed, allowing the water to flow until all the air has been expelled.
- At this point the water will only be at low pressure.



BEFORE USE

ADDING FUEL (FOR HOT WASHING)

- Refuel in a well-ventilated area.
 - Do not leave fuel within the reach of children.
 - Refuel carefully to avoid spillages.
1. Remove the diesel filler cap and fill the tank with diesel fuel.
 - Maximum 3 litres.
 2. Replace the diesel filler cap securely.

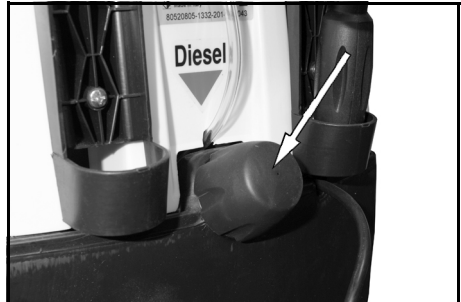

WARNING: INCORRECT FUELS MUST NOT BE USED AS THEY CAN BE HAZARDOUS.

FILLING WITH DETERGENT

If you intend to use the detergent facility:

1. Unscrew the detergent filler cap and fill the container with detergent.
 - Only use detergents recommended for use with the hot washers, such as CLARKE Traffic Film Remover which is a powerful 'low foaming' agent for car cleaning, patio cleaning etc., or CLARKE Wash & Wax, both available from your CLARKE dealer.



WARNING: THE USE OF UNSUITABLE CLEANING AGENTS MAY ADVERSELY AFFECT THE SAFETY OF THE HOT WASHER. DO NOT EXCEED THE CORRECT OPERATING TEMPERATURE.

USING THE PRESSURE WASHER

AUTOMATIC STOP SYSTEM

The Automatic Stop System stops the hot washer during the bypass phase.

Once the hot washer is switched on, the 'Automatic Stop System' will start and stop the hot washer automatically whenever the trigger is pulled / released.

Sometimes the hot washer may start without pressing the gun trigger, this is normally due to air bubbles in the water or other similar phenomena which do not imply the existence of any defects in the hot washer.

Do not leave the hot washer unattended during the bypass phase for more than 5 minutes. If you need to leave the hot washer for longer than this, switch it off first, and operate the trigger to release the pressure.

STARTING UP

1. Connect the plug to the power socket.

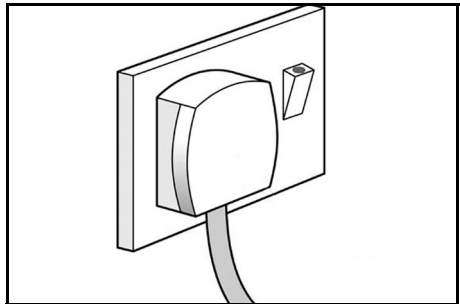

RELEASE THE TRIGGER LOCK

1. To release the trigger lock, lift the lock upwards and lay it against the trigger as shown.



SWITCHING ON

TO WASH WITH COLD WATER

1. To start the pressure washer, squeeze and hold the gun trigger while you press '1' on the master switch.

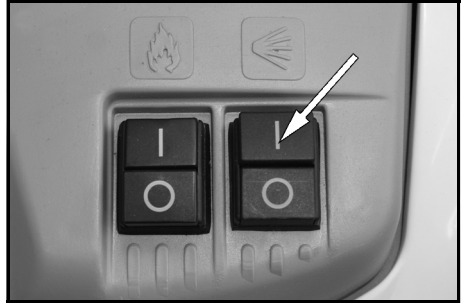

TO WASH WITH HOT WATER:

1. To start the pressure washer, squeeze and hold the gun trigger while you press '1' on the master switch.
2. Press (I) ON on the burner switch
 - The water will reach a maximum temperature of 90°C.
 - The burner will cycle on/off as required.

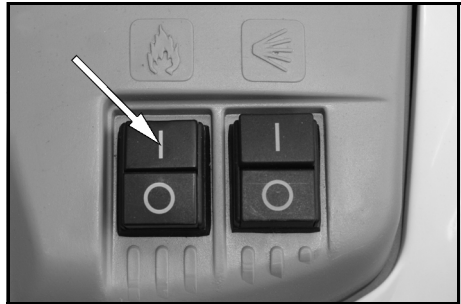

ADJUSTING THE SPRAY

To adjust the water delivery from a narrow jet of water to a wide spray, proceed as follows:

1. With the nozzle pointing away from you and anyone else, hold the shaft of the lance in one hand.
2. Twist the nozzle with the other hand.
3. The spray varies between narrow and wide as you turn the nozzle.

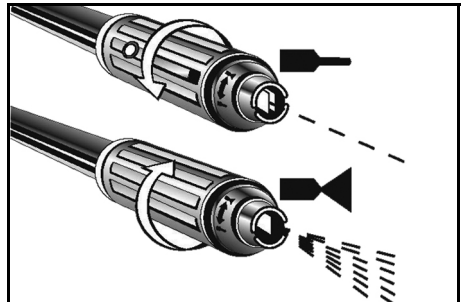

USING DETERGENT

1. Slide the nozzle forward for low pressure operation.
2. Pull the trigger to spray the detergent.
 - The detergent can ONLY be sprayed when the nozzle is in low pressure mode.

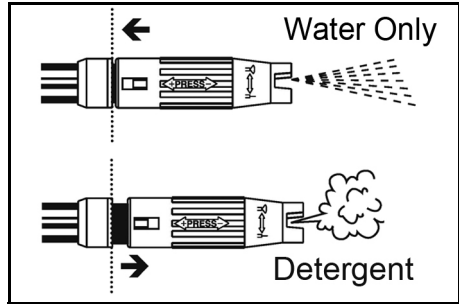

CAUTION: IF YOUR EYES COME INTO CONTACT WITH ANY CLEANING FLUIDS, RINSE THEM IMMEDIATELY WITH PLENTY OF CLEAN WATER AND SEEK MEDICAL ADVICE IF REQUIRED.

SWITCHING OFF

1. Press (0) on the burner switch
2. Press (0) on the master switch
3. Pull the trigger and wait until the unpressurised water goes completely cold.
 - In this way you avoid any calcium deposit and overheating of the coil and the boiler.
4. Remove the plug from the power supply.
5. Release any pressure in the hose by pulling the trigger.
6. Engage the trigger lock.

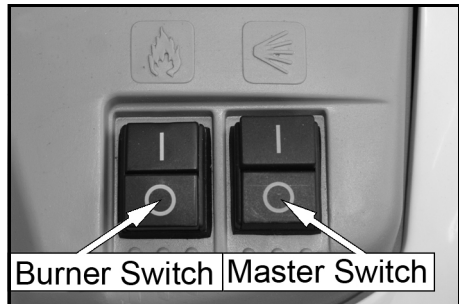

CARE AND MAINTENANCE



WARNING: THE HOT WASHER MUST BE DISCONNECTED FROM ITS POWER SOURCE, BY REMOVING THE PLUG FROM THE SOCKET OUTLET, DURING CLEANING OR MAINTENANCE.



WARNING: DO NOT SPRAY THE HOT WASHER WITH WATER OR DETERGENTS/AGGRESSIVE SOLVENTS. THE HOT WASHER COULD BE DAMAGED.

CLEAN THE EXTERIOR PART OF THE HOT WASHER WITH A DRY CLOTH

- Always keep the hot washer clean so that cooling air can pass through the air vents without obstruction.

CLEANING THE WATER FILTER

To ensure the pump gives good service it is extremely important to check and clean the water filter frequently.

1. Remove filter from the water inlet of the pump as shown.
2. Clean the inside and outside of the filter by flushing it with water.
3. Refit the filter into the water inlet.

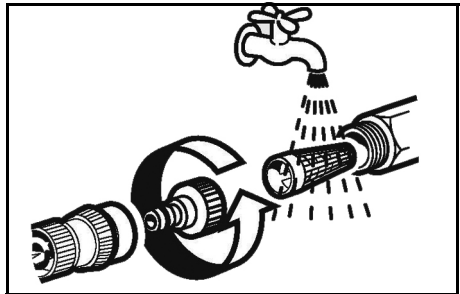

- Do not operate the hot washer without the filter in place.

CLEANING THE NOZZLE

A blockage in the nozzle may prevent the hot washer from operating correctly so it must be kept clear.

1. Switch off the hot washer.
2. Pull trigger on the gun handle to release any water pressure.
3. Remove the lance.
4. Clean the nozzle with the pin provided.
5. Rinse the lance in running water.

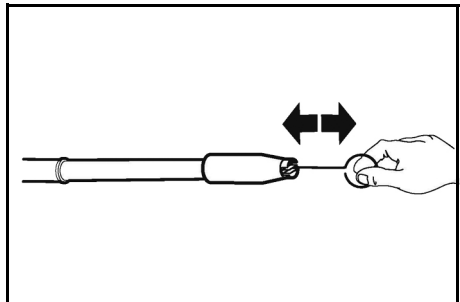

STORAGE

- Move the hot washer only by grasping the carrying handle.
- Store the hot washer and the accessories in a frost-free room.

DE-COMMISSIONING PRODUCT

Should the product become completely unserviceable and require disposal, draw off the oil into an approved container and dispose of the product and the oil according to local regulations.



Recycle unwanted materials instead of disposing of them as waste. All tools, accessories and packaging should be sorted, taken to a recycling centre and disposed of in a manner which is compatible with the environment.

CONSUMABLES ETC

A range of suitable hoses, shampoo and traffic film remover are available from your Clarke dealer.



TROUBLESHOOTING

PROBLEM	POSSIBLE CAUSE	SOLUTION
No water delivery.	Water filter blocked.	See "Cleaning the water filter" on page 12.
	Pump valves jammed.	Contact Clarke Service Department.
	Clogged lance nozzle.	Clean the nozzle.
Low or irregular pressure	Insufficient water supply.	Check connections.
	Pump taking in air.	Check connections.
	Detergent valve sucking in air.	Check connections and that detergent supply is topped up
	Water filter dirty.	Clean or replace.
	Worn out gaskets or valve components.	Contact Clarke Service Department for replacement.
	Exceeding the inlet water temperature.	Make sure the water supply is below 40 degrees.
	Damaged or worn out nozzle components.	Contact Clarke Service Department for replacement
	Coil is covered in limescale.	Contact Clarke Service Department for advice on de-scaling.
The burner does not turn on.	Dirty burner nozzle.	Contact Clarke Service Department.
	Faulty thermostat.	Contact Clarke Service Department.
	Broken/blocked actuated valve.	Contact Clarke Service Department.
	Dirty fuel filter.	Contact Clarke Service Department.
	Insufficient spark at the electrodes.	Contact Clarke Service Department.
	Worn out pump mechanism.	Contact Clarke Service Department.
	Low voltage.	Make sure the hot washer is connected to a suitable power supply.

the hot washer is noisy.	Air intake worn out / dirty/ blocked valves. Excess water temperature.	Check air inlet. Contact Clarke Service Department. Reduce water temperature.
Oil leaking from the pump.	Worn out o-rings or gaskets.	Contact Clarke Service Department.
Motor suddenly stops.	Thermal protection has activated due to overheating.	Switch off the hot washer and wait until the unit has cooled down sufficiently.

PRODUCT SPECIFICATIONS

Model Number	KING150
Part Number	7320175
Voltage	230 V / 50 Hz / 1 Phase
Rated Input Power	2300 W (HOF)
Duty Cycle	S1 (continuous)
Fuel Type	Diesel
Max Inlet Water Pressure	6 Bar
Working Pressure	100 Bar
Maximum Output Pressure	145 Bar
Maximum Output Flow Rate	7.5 Litres / minute
Maximum Output Temperature	90°C
Maximum Input Temperature	40°C
Fuel Tank Capacity	3 Litres
Detergent Tank Capacity	2 Litres
IP Rating	IPX5
Sound Power Level (L_{WA})	89 dB
Guaranteed Sound Power Level (L_{WA})	92 dB
Vibration	1.73 m/s^2
Uncertainty Factor	+/- 15%
Dimensions (L x W x H)	637 x 405 x 963 mm
Weight	40 kg

DECLARATION OF CONFORMITY



Clarke[®]
INTERNATIONAL

Hemnal Street, Epping, Essex CM16 4LG

DECLARATION OF CONFORMITY

This is an important document and should be retained.

We hereby declare that this product(s) complies with the following directive(s):

- 2004/108/EC *Electromagnetic Compatibility Directive.*
- 2006/42/EC *Machinery Directive.*
- 2006/95/EC *Low Voltage Equipment Directive.*
- 2000/14/EC *Noise Emissions Directive, (amended by 2005/88/EC).*
- 97/23/EC *Pressure Equipment Directive.*

The following standards have been applied to the product(s):

- EN 60335-1, EN 60335-2-79, EN 55014-1:2006+A1:2009+A2:2011,
- EN 55014-2, 1997+A1:2001+A2:2008, EN 61000-3-2:2006+A1:2009+A2:2009,
- EN 61000-3-3:2008, EN 61000-3-11:2000, EN 62233, EN 61000-3-11.

The technical documentation required to demonstrate that the product(s) meet(s) the requirement(s) of the aforementioned directive(s) has been compiled and is available for inspection by the relevant enforcement authorities.

The CE mark was first applied in: 2014

Signed:

J.A. Clarke
Director

DECLARATION OF CONFORMITY



Clarke[®]
INTERNATIONAL

Hemnall Street, Epping, Essex CM16 4LG

DECLARATION OF CONFORMITY

This is an important document and should be retained.

Product Description: King 150 Hot Pressure Washer

Model number(s): 7320175

Serial / batch Number: N/A

Date of Issue: 08/09/2015

(Noise Conformity)

Notified Body: European Manufacturer

Technical Documentation Holder: A.R. Pond
Clarke International
2a Shrubland Road
London E10,7RB
UK

Conformity Assessment Procedure: to 2000/14/EC Annex VI

Manufacturer: Clarke International

Noise Related Value: 2.3 kW

Measured Sound Power Level: 89 dB

Guaranteed Sound Power Level: 92 dB

A SELECTION FROM THE VAST RANGE OF

Clarke®

QUALITY PRODUCTS

AIR COMPRESSORS

From DIY to industrial, Plus air tools, spray guns and accessories.

GENERATORS

Prime duty or emergency standby for business, home and leisure.

POWER WASHERS

Hot and cold, electric and engine driven - we have what you need

WELDERS

Mig, Arc, Tig and Spot. From DIY to auto/industrial.

METALWORKING

Drills, grinders and saws for DIY and professional use.

WOODWORKING

Saws, sanders, lathes, mortisers and dust extraction.

HYDRAULICS

Cranes, body repair kits, transmission jacks for all types of workshop use.

WATER PUMPS

Submersible, electric and engine driven for DIY, agriculture and industry.

POWERTOOLS

Angle grinders, cordless drill sets, saws and sanders.

STARTERS/CHARGERS

All sizes for car and commercial use.



PARTS & SERVICE: 0208 988 7400

E-mail: Parts@clarkeinternational.com or Service@clarkeinternational.com

SALES: UK 01992 565333 or Export 00 44 (0)1992 565335

Clarke® INTERNATIONAL Hemnall Street, Epping, Essex CM16 4LG
www.clarkeinternational.com